

# Weidmann

## Operating Instructions for the WEIDMANN Type HWP5 Piercing Press with table



**WEIDMANN MASCHINENBAU AG**

Margarethenstrasse 27, CH-8152 Glattbrugg

info@weidmann-maschinenbau.com / Tel. +41 (0)44 810 62 06 / Fax +41 (0)44 810 87 81 / [www.weidmann-maschinenbau.com](http://www.weidmann-maschinenbau.com)

# Content

The purpose of these operating instructions .....	2
General safety information and general safety instructions .....	2
Description of the piercing press.....	2
Intended use .....	2
Important information about the piercing press .....	2
Transport, handling and storage of the piercing press and/or components .....	3
Setting up.....	6
Tool fixing.....	6
Operating the press (production) .....	7
Cleaning.....	7
Maintenance .....	8
Replacing the Teflon brake disks .....	8
Production stoppage.....	9
Malfunction of the piercing press .....	9
Taking out of service.....	9
Disposal .....	10
CE Conformity Declaration .....	10
Dimension Diagram (Layout/Plan View) .....	11
Drawing of Punch Insert.....	12
Illustration of all Parts/Replacement Parts .....	13
Datasheet for HSA Anchor Fixings by Hilti.....	14

## The purpose of these operating instructions

These operating instructions must be retained for the entire service life of the piercing press and must be observed whenever any activities are undertaken in connection with the piercing press.

If you sell the piercing press on to a third party, you must hand these operating instructions over to the purchaser concerned.

## General safety information and general safety instructions

You may be exposed to the risks set out below whenever you use the piercing press, and you must therefore take the following protective measures:

**The spindle dropping down:** Always be sure to apply the brake on the spindle .....



**Parts falling off:** Wear safety shoes in line with EN20345



**Parts flying off:** Wear safety goggles in line with EN166 and protective gloves



## Description of the piercing press

Mechanical piercing press, manually operated.

The manufacturer rejects all liabilities for any defects that may arise as a result of any modification that may have been made to the piercing press without the written approval of the manufacturer.

## Intended use

This press is intended for use by adults within indoor spaces in trading and industrial premises.

These presses can be used for all pressing-in and pressing-out operations, at pressure forces of up to 5 tonnes. The press is also suitable for the following tasks: broaching, straightening, pressing, bending, riveting, embossing, stamping and assembly tasks.

The following are examples of improper use: splitting wood and the simultaneous operation of the hand wheel by more than one person.

Only those people who have read the necessary information within the operating instructions may work with the press, or interfere with the press or its operation.

## Important information about the piercing press

The piercing press is constructed in line with the current status of technology and meets the requirements of the Swiss Federal Law on Product Safety, as well as the Swiss Ordinance on Product Safety.

Dimension Diagram (Layout/Plan view), see Page 11

Drawing of Punch Insert, see Page 12

Illustration of All Parts /Replacement Parts, see Page 13

Datasheet for HSA Stud Anchors by Hilti, see Pages 14/15

## Transport, handling and storage of the piercing press and/or components

The following people may be involved in these procedures: third parties; mechanics; transport agents

The following procedure must be adopted when you transport the piercing press:

- ◆ Prepare a mini pallet 80x60 cm and 1 wooden batten, measuring 520 mm
- ◆ Use straps to secure the vertical piercing press at the press head. See “Dimension Diagram” on Page 11.
- ◆ Lift the piercing press

### **Risk caused by gravitational force**

**Check strap for damage and carrying capacity. The weight of the piercing press is set out in the “Dimension Diagram” on Page 11.**

**Suspend the strap from the crane hook in accordance with the instructions**

**Secure the strap in accordance with the “Dimension Diagram” on Page 11**



- ◆ Use a crane to position the piercing press in the centre of the pallet
- ◆ Use the hand wheel (ring or star-shaped hand wheel) to lift the press spindle all the way to the top
- ◆ Lay the wooden batten transversely across the press table and secure to the pallet with a steel strap

**Risk of the steel straps flying off into a person’s eyes and when they are cut  
Wear protective glasses in accordance with EN166**

**Wear protective gloves**



- ◆ Move the press spindle completely to its lowest position and apply the spindle brake

**Risk of crushing**

**Do not place your hands within the area of risk caused by the spindle**



**Risk of being pulled in**

**Do not touch the gear rim**



- ◆ Pack the piercing press
- ◆ Use a pallet truck to transport the pallet, in accordance with instructions
- ◆ Unload the piercing press from the pallet: see section on “Putting into operation” on page 4

The following procedure must be adopted when you transport the table:

- ◆ Prepare a small pallet 80x60 cm and 1 wooden batten, measuring 520 mm
- ◆ Use 2 straps positioned diagonally on the table plate to secure the table in a vertical position. See Dimension Diagram on Page 11.
- ◆ Lift the table

**Risk caused by gravitational force**

**Check strap for damage and carrying capacity. The weight of the table is set out in the “Dimension Diagram” on Page 11.**

**Suspend the strap from the crane hook in accordance with the instructions**

**Secure the strap in accordance with the “Dimension Diagram” on Page 11**



- ◆ Use a crane to position the table in the centre of the pallet
- ◆ Lay the wooden batten horizontally over the tray (below) and secure to the pallet with a steel strap.

**Risk of the steel straps flying off into a person’s eyes and when they are cut**  
**Wear protective glasses in accordance with EN166**

**Wear protective gloves**



- ◆ Pack the table
- ◆ Use a pallet lifting truck to transport the pallet
- ◆ Unload the table from the pallet: see section on bringing into service on Page 4

### Putting into operation

This operation may be undertaken by: third parties; mechanics

**Use the procedure described below to bring the piercing press and table into service:**

- ◆ Cut off the steel straps

**Risk of the steel straps flying off into a person’s eyes and when they are cut**  
**Wear protective glasses in accordance with EN166**

**Wear protective gloves**



- ◆ Unpack the press and table
- ◆ Use 2 straps to secure the vertical table diagonally in a vertical position by the table plate, see Dimension Diagram on Page 11.

- ◆ Lift the table

**Risk caused by gravitational force**

Check strap for damage and carrying capacity. The weight of the table is set out in the “Dimension Diagram” on Page 11.

Suspend the strap from the crane hook in accordance with the instructions

Secure the strap in accordance with the “Dimension Diagram” on Page 11



- ◆ Use a crane to position the table at the intended location and loosen the belt

**Risk caused by gravitational force / risk of tipping over**

Set the table only on a base surface that is clean and even so that the base surface is suitable for the Hilti HSA stud anchors



- ◆ Use Hilti HSA M12 stud anchors to secure the table in the holes in the floor drilled for this purpose (see Datasheet on Page 14/15).
- ◆ Check whether the spindle brake is applied; if not, apply it now
- ◆ Use straps to secure the vertical piercing press at the press head. See “Dimension Diagram” on Page 11
- ◆ Lift the piercing press and position it on the table, which is already anchored to the floor

**Risk caused by gravitational force**

Check strap for damage and carrying capacity. The weight of the piercing press is set out in the “Dimension Diagram” on Page 11.

Suspend the strap from the crane hook in accordance with the instructions

Secure the strap in accordance with the “Dimension Diagram” on Page 11

Set up the piercing press where you can ensure the necessary free space is available (see the “Dimension diagram” on Page 11).

Please note that there must also be enough ambient lighting to carry out the work.



- ◆ Loosen the belt
- ◆ Use the screws delivered with the press to secure it to the table at the 4 fixing holes intended for this purpose
- ◆ Locate the rotary table in the indentation provided in the table plate

**Risk caused by incorrect loading**

For workpieces weighing more than 5 kg, use the following method to evaluate the handling method:

[www.suva.ch/88190.d](http://www.suva.ch/88190.d). Use lifting gear if necessary.



## Setting up

This operation may be undertaken by: users; third parties; mechanics

The following method must be used for setting up:

- ◆ Check whether the spindle brake is applied; if not, apply it now

### **Risk of crushing**

**Do not place your hands within the area of risk caused by the spindle**

**Apply the spindle brake**



### **Risk of being pulled in**

**Do not touch the gear rim**



- ◆ Rotate the rotary table to the required slot width
- ◆ Remove the rotary table if it is not in use

### **Risk caused by incorrect loading**

**For workpieces weighing more than 5 kg, use the following method to evaluate the handling method:**

[www.suva.ch/88190.d](http://www.suva.ch/88190.d). Use lifting gear if necessary.



## **Tool fixing**

- ◆ Hold the insert punch/tool underneath on the press spindle
- ◆ Loosen the clamping screw on the press spindle
- ◆ Remove the insert punch/tool
- ◆ Insert the insert punch/tool
- ◆ Use the clamping screw on the press spindle to secure the insert punch/tool

### **Risk caused by falling objects**

**Any insert punches/tools not fabricated by the manufacturer must be manufactured in accordance with the drawing of the insert punch on Page 12**

**If the insert punch/tool is loose, tighten the clamping screw.**



## Operating the press (production)

This operation may be undertaken by: users; third parties; mechanics

At the operational stage (production), the procedure below must be followed:

- ◆ Take the workpiece and place it upon the rotary table or table plate

### **Risk caused by incorrect loading**

**For workpieces weighing more than 5 kg, use the following method to evaluate the handling method:**

[www.suva.ch/88190.d](http://www.suva.ch/88190.d). Use lifting gear if necessary.



- ◆ Take the insert and place it in the intended location on the workpiece
- ◆ Use the hand wheel (ring or star-shaped hand wheel) to move the press spindle onto the workpiece

### **Risk of crushing**

**Do not place your hands within the area of risk caused by the spindle**

**Apply the spindle brake**



### **Risk of being pulled in**

**Do not touch the gear rim**



- ◆ The press spindle may only be moved if no part of the body is within the area of risk
- ◆ The press spindle presses on the workpiece
- ◆ Use the press spindle to press the workpiece at the required position
- ◆ Raise the press spindle
- ◆ Remove the workpiece

### **Risk caused by incorrect loading**

**For workpieces weighing more than 5 kg, use the following method to evaluate the handling method:**

[www.suva.ch/88190.d](http://www.suva.ch/88190.d). Use lifting gear if necessary.



## Cleaning

This operation may be undertaken by: users; third parties

Cleaning tasks must be carried out as follows:

- ◆ Use a cleaning cloth to clean the press spindle on a weekly basis



## Maintenance

This operation may be undertaken by: third parties; mechanics

### Maintenance tasks must be carried out as follows:

- ◆ Use slideway oil to lubricate the press spindle on a weekly basis
- ◆ Use a universal grease to lubricate the grease nipple on the drive mechanism every 6 months
- ◆ Check the Teflon brake disk on the hand wheel every year and replace as necessary

### Replacing the Teflon brake discs

Only original replacement parts may be used for this procedure (Order no.: Teflon brake disk).

- ◆ Lower the press spindle onto the table plate

#### **Risk of crushing**

**Do not place your hands within the area of risk caused by the spindle**

**Apply the spindle brake**



#### **Risk of being pulled in**

**Do not touch the gear rim**



- ◆ Loosen and then remove the screw on the gear rim
- ◆ Remove the gear rim.  
If the gear rim is stuck, turn an M12 screw inside the thread and use a hammer to strike the head of that screw
- ◆ Take the gear rim off the spindle
- ◆ Loosen and remove the star handle in the centre of the hand wheel
- ◆ Remove the plate washer and spacing washer
- ◆ Remove the hand wheel
- ◆ Remove the slot key
- ◆ Remove the Teflon brake disc
- ◆ Pull the pinion out
- ◆ Remove and replace the Teflon brake disc on the toothed side
- ◆ Replace the pinion
- ◆ Replace the Teflon brake disc
- ◆ Insert the slot key
- ◆ Mount the hand wheel

- ◆ Fit the galvanised spacing washer
- ◆ Fit the black plate washer with the indentation onto the hand wheel
- ◆ Fit and tighten the star handle in the centre of the hand wheel
- ◆ Slide on the gear rim
- ◆ Use a screw to fix the gear rim in place

### **Production stoppage**

This operation may be undertaken by: third parties; mechanics

#### **The following procedure must be used in the event of production stoppages:**

- ◆ Rotary table (slot width) in the wrong position: turn to the correct position as necessary
- ◆ Foreign body between table plate and workpiece: remove foreign body as necessary

### **Malfunction of the piercing press**

This operation may be undertaken by: third parties; mechanics

#### **The following procedure must be used in the event of a malfunction of the piercing press:**

- ◆ The press spindle lowers of its own accord: apply the spindle brake

### **Taking out of service**

This operation may be undertaken by: third parties; mechanics

#### **The following procedure must be used to take the equipment out of service:**

- ◆ Raise the rotary table and lift it out of the centring hole on the table
- ◆ Move the press spindle completely to its lowest position and apply the spindle brake

#### **Risk of crushing**

**Do not place your hands within the area of risk caused by the spindle**



#### **Risk of being pulled in**

**Do not touch the gear rim**



- ◆ Loosen the screws in the holes fixing the press to the table
- ◆ Use a crane to lay the piercing press on a pallet (see Transportation operating mode on Page 3)
- ◆ Loosen the Hilti HSA anchor fixings on the floor surface
- ◆ Use a crane to lay the table on a pallet (see Transportation operating mode on Page 3)

## Disposal

This operation may be undertaken by: third parties; mechanics; transportation providers, disposal specialists

### The following procedure must be used for disposal of the equipment:

- ◆ Remove oil and grease
- ◆ Dismantle plastic components and dispose of them correctly
- ◆ Dispose of metal components correctly

## CE Conformity Declaration

We hereby declare that we **may not attach any CE label** to our piercing presses, since these presses are operated solely by human effort and do not include any lifting procedures. As a result, they do not fall within the scope of EU Machinery Directive 2006/42/EC.

### Extract from EU Machinery Directive 2006/42/EC

Within the meaning of Article 1 of the Machinery Directive, machines must, according to Article 2 of the Machinery Directive, exhibit one of the following characteristics in respect of their drive systems:

- an assembly, fitted with or intended to be fitted with a drive system other than directly applied human or animal effort, consisting of linked parts or components, at least one of which moves, and which are joined together for a specific application
- an assembly of linked parts or components, at least one of which moves and which are joined together, intended for lifting loads and whose only power source is directly applied human effort.



# Drawing of Punch Insert

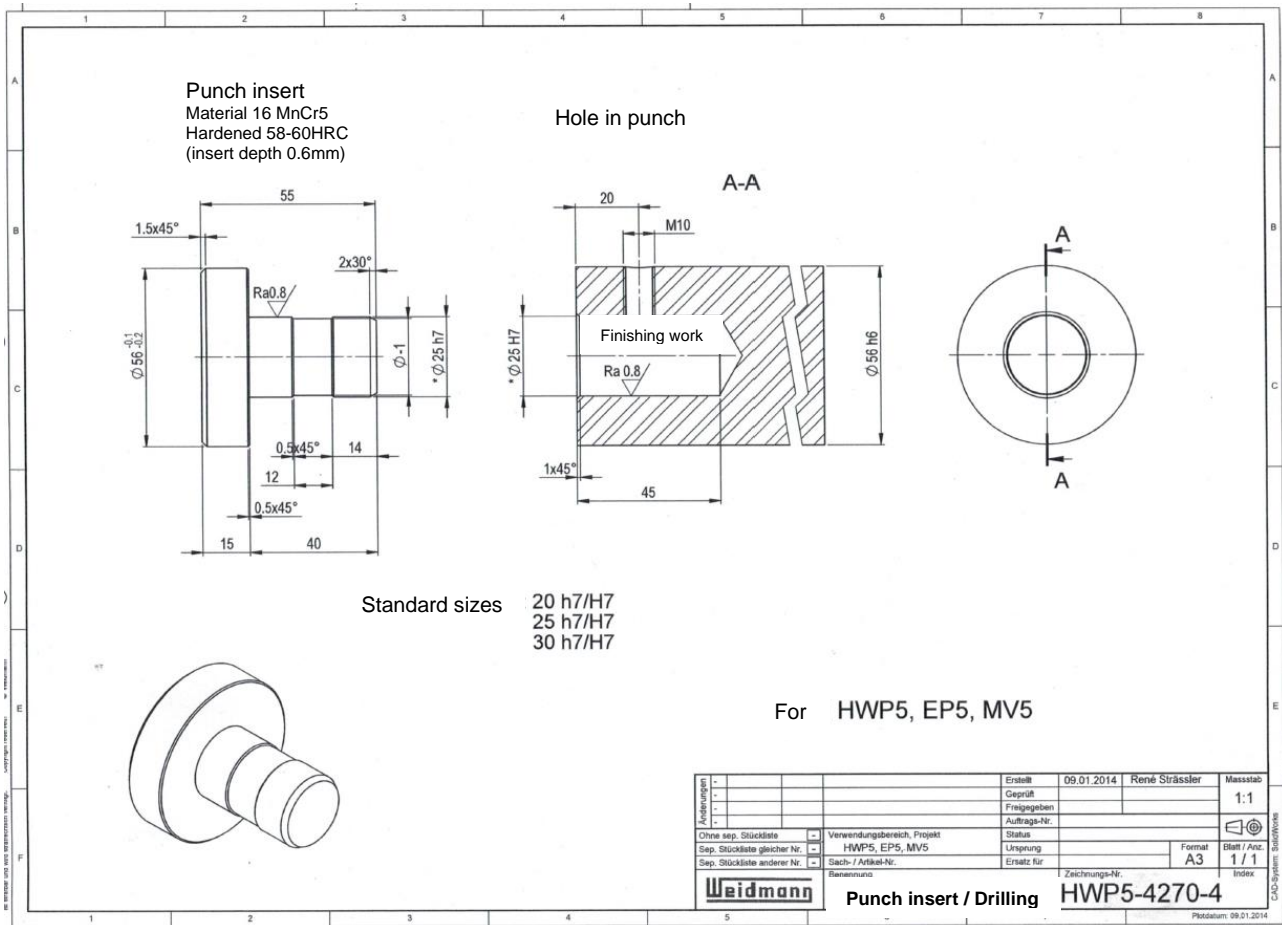

# Illustration of all Parts/Replacement Parts

Nr	Spare parts	Qty	Weight
1	4264	1	6.615
2	4251	1	126.625
3	4255	1	1.746
4	4253	1	13.345
5	4257	2	1.031
6	4261	1	9.465
7	4258	1	1.591
8	4262S	1	6.279
9	4262R	1	13
10	Table	1	17
11	Ball handle	5	0.05
12	Star handle	1	0.03
13	Grease nipple	1	0.023
14	Slide bush	2	0.143
15	Brake disc Teflon	1	0.001
16	Brake disc Teflon	1	0.001
17	Disc spring	1	0.012
18	Washer	1	0.018
19	Washer	1	0.036
20	Screw flange bearing	6	0.01
21	Screw gear ring	1	0.04
22	Wedge	1	0.021
23	Wedge	1	0.024

**Weidmann Spare parts**

**WEIDMANN MASCHINENBAU** Bemerkungen : Typ HWP5 A4

Datiert : 17/03/2022





Weidmann Maschinenbau AG CH-8152 Glattbrugg

# Datasheet for HSA Anchor Fixings by Hilti

Technische Daten Metalldübel



## Segmentanker HSA

Ankertyp		Merkmale & Nutzen
	HSA (Galvanisch verzinkt)	<ul style="list-style-type: none"> <li>• Geeignet für ungerissenen Beton C 20/25 bis C 50/60</li> <li>• Schnelles und sicheres Aufbringen des Montagedrehmomentes mittels Tangentialschlagschrauber und Spezialnuss möglich</li> <li>• 3 Einbindetiefen für höchste Flexibilität</li> <li>• Diamantbohren für M12 bis M20 in ETA geregelt</li> <li>• Zeitsparende und zulassungskonforme Montage mit dem Schlagschrauber SIW 22-A/14-A i.V.m. dem Drehmomentstab S-TB</li> </ul>
	HSA-BW mit grosser Unterlegscheibe (Galvanisch verzinkt)	
	HSA-R (Nichtrostender Stahl A4) (Auf Anfrage auch in A2)	
	Drehmomentstab S-TB (M8, M10, M12, M16)	



## Zulassungen/Prüfberichte

Beschreibung	Behörde/Prüfstelle	Nummer
Europäisch Technische Zulassung <sup>*)</sup>	DIBt, Berlin	ETA-11/0374
Brandschutzprüfbericht	IBMB, Braunschweig	3215/229/12



<sup>\*)</sup> Alle in diesem Abschnitt angegebenen Daten laut ETA-11/0374.

## Lastdaten (für Einzelbefestigungen).

Alle Daten in diesem Abschnitt basieren auf folgenden Grundlagen:

- Korrekte Montage (siehe Montageanweisung).
- Kein Einfluss von Achs- und Randabständen.
- Einhaltung der Mindestbauteildicke.
- Ungerissener Beton C 20/25,  $f_{ct,cube} = 25 \text{ N/mm}^2$ .

## Geprüfte Befestigungen im vorbeugenden baulichen Brandschutz für Segmentanker HSA/HSA-R

Prüfungen		 		<ul style="list-style-type: none"> <li>• Geprüft nach der international genormten Einheitstemperaturkurve (ISO 834, DIN 4102-2)</li> <li>• Geprüft im gerissenen Beton bei direkter Beflammung ohne schützende Maßnahmen</li> </ul>	
Bericht des IBMB Technische Universität Braunschweig Nr.		3049/8151			
		Maximale Lasten [kN] für geforderte Feuerwiderstandsdauer			
		90 min		120 min	
HSA	M6	0,3		0,25	
	M8	0,5		0,4	
	M10	1,3		1,0	
	M12	1,8		1,2	
	M16	4,0		3,0	
	M20	7,0		5,0	
HSA-R	M6	0,8		0,6	
	M8	1,8		1,2	
	M10	3,0		2,5	
	M12	4,0		3,0	
	M16	7,5		6,0	

**Technische Daten für Segmentanker HSA/HSA-R**

• Auszug aus den Anwendungsbedingungen der Zulassung nach Bemessungsverfahren A (ETAG Annex C, 1997).

Zulassung				ETA-11/0374 vom 19.07.2012					
Verankerungsgrund				Beton $\geq$ C20/25 (B25)					
				HSA					
				M6	M8	M10	M12	M16	M20
Bohrdurchmesser	d	[mm]		6	8	10	12	16	20
Durchgangsbohrung im Anbauteil	d <sub>f</sub>	[mm]		7	9	12	14	18	22
Drehmoment beim Verankern	T <sub>inst</sub>	[Nm]		5	15	25	50	80	200
Schlüsselweite	SW	[mm]		10	13	17	19	24	30
Verankerungstiefe 1	<b>Gerissener Beton mit reduzierter (h<sub>nom1</sub>) Verankerungstiefe:</b>								
	<sup>1)</sup> Zulässige Zuglast je Dübel	N <sub>zul</sub>	[kN]	-	-	-	-	-	-
	<sup>1)</sup> Zulässige Querlast je Dübel	V <sub>zul</sub>	[kN]	-	-	-	-	-	-
	<b>Ungerissener Beton mit reduzierter (h<sub>nom1</sub>) Verankerungstiefe:</b>								
	<sup>1)</sup> Zulässige Zuglast je Dübel	N <sub>zul</sub>	[kN]	2,9	4,0	6,1	8,5	12,6	15,6
	<sup>1)</sup> Zulässige Querlast je Dübel	V <sub>zul</sub>	[kN]	3,7	4,0	10,8	16,9	29,1	31,2
	<b>Gerissener/Ungerissener Beton mit reduzierter (h<sub>nom1</sub>) Verankerungstiefe:</b>								
	<sup>4)</sup> Achsabstand	s <sub>cr</sub>	[mm]	90	90	120	150	195	225
	<sup>4)</sup> Randabstand	c <sub>cr</sub>	[mm]	45	45	60	75	97	113
	<sup>5)</sup> Minimaler Achsabstand	s <sub>min</sub>	[mm]	35	35	50	70	90	195
<sup>5)</sup> Minimaler Randabstand	c <sub>min</sub>	[mm]	35	40	50	70	80	130	
Bohrlochtiefe	h <sub>nom1</sub>	[cm]	4,2	4,4	5,5	7,2	8,5	9,8	
Mindestbauteildicke	h <sub>min</sub>	[mm]	100	100	100	100	140	160	
Verankerungstiefe 2	<b>Gerissener Beton mit Standard (h<sub>nom2</sub>) Verankerungstiefe:</b>								
	<sup>1)</sup> Zulässige Zuglast je Dübel	N <sub>zul</sub>	[kN]	-	-	-	-	-	-
	<sup>1)</sup> Zulässige Querlast je Dübel	V <sub>zul</sub>	[kN]	-	-	-	-	-	-
	<b>Ungerissener Beton mit Standard (h<sub>nom2</sub>) Verankerungstiefe:</b>								
	<sup>1)</sup> Zulässige Zuglast je Dübel	N <sub>zul</sub>	[kN]	3,6	6,1	8,5	12,6	17,2	24,0
	<sup>1)</sup> Zulässige Querlast je Dübel	V <sub>zul</sub>	[kN]	3,7	6,1	10,8	16,9	29,1	49,0
	<b>Gerissener/Ungerissener Beton mit Standard (h<sub>nom2</sub>) Verankerungstiefe:</b>								
	<sup>4)</sup> Achsabstand	s <sub>cr</sub>	[mm]	120	120	150	195	240	300
	<sup>4)</sup> Randabstand	c <sub>cr</sub>	[mm]	60	60	75	97	120	150
	<sup>5)</sup> Minimaler Achsabstand	s <sub>min</sub>	[mm]	35	35	50	70	90	175
<sup>5)</sup> Minimaler Randabstand	c <sub>min</sub>	[mm]	35	35	40	65	75	120	
Bohrlochtiefe	h <sub>nom2</sub>	[cm]	5,2	5,4	6,5	8,7	10,0	12,3	
Mindestbauteildicke	h <sub>min</sub>	[mm]	100	100	120	140	160	220	
Verankerungstiefe 3	<b>Gerissener Beton mit erhöhter (h<sub>nom3</sub>) Verankerungstiefe:</b>								
	<sup>1)</sup> Zulässige Zuglast je Dübel	N <sub>zul</sub>	[kN]	-	-	-	-	-	-
	<sup>1)</sup> Zulässige Querlast je Dübel	V <sub>zul</sub>	[kN]	-	-	-	-	-	-
	<b>Ungerissener Beton mit erhöhter (h<sub>nom3</sub>) Verankerungstiefe:</b>								
	<sup>1)</sup> Zulässige Zuglast je Dübel	N <sub>zul</sub>	[kN]	4,3 <sup>2)</sup>	7,6 <sup>2)</sup>	11,9	16,7	23,8	29,7
	<sup>1)</sup> Zulässige Querlast je Dübel	V <sub>zul</sub>	[kN]	3,7 <sup>2)</sup>	6,1 <sup>2)</sup>	10,8	16,9	29,1	49,0
	<b>Gerissener/Ungerissener Beton mit erhöhter (h<sub>nom3</sub>) Verankerungstiefe:</b>								
	<sup>2)</sup> Achsabstand	s <sub>cr</sub>	[mm]	180 <sup>2)</sup>	210 <sup>2)</sup>	240	300	360	345
	<sup>2)</sup> Randabstand	c <sub>cr</sub>	[mm]	130 <sup>2)</sup>	105 <sup>2)</sup>	120	150	180	173
	<sup>4)</sup> Minimaler Achsabstand	s <sub>min</sub>	[mm]	35 <sup>2)</sup>	35 <sup>2)</sup>	50	70	90	175
<sup>4)</sup> Minimaler Randabstand	c <sub>min</sub>	[mm]	35 <sup>2)</sup>	35 <sup>2)</sup>	40	55	70	120	
Mindestbauteildicke	h <sub>min</sub>	[mm]	120	120	160	180	180	220	
Bohrlochtiefe	h <sub>nom3</sub>	[cm]	7,2	8,4	9,5	12,2	14	13,8	

1) Lasten gelten für randferne Einzelbefestigung ohne dichte Bewehrung, Teilsicherheitsbeiwert  $\gamma_1 = 1,0$  für Betonversagen (ETAG 001, Progress File).  
 2) Beschränkt auf redundante Verankerungen (Mehrfachbefestigungen)  
 3) Bei Randabstand  $c \geq c_{cr}$  und Achsabstand  $s \geq s_{cr}$  ist  $N_{zul}$  (Gruppe) =  $N_{zul}$  x Dübelanzahl der Gruppe  
 4) Die zulässige Last muss bei  $s_{min} \leq s \leq s_{cr}$  und oder  $c_{min} \leq c \leq c_{cr}$  entsprechend Bemessungsverfahren A (ETAG Annex C, 1997) reduziert werden.